

VOWELS

EN ingles, las vocales tienen 2 sonidos: sonido LARGO y sonido CORTO

Short	a	e	i	o	u
Long	/ei/	/i/	/ai/	/ou/	/iu/

SHORT Vowel Sounds



A

E

I

O

U

LONG Vowel Sounds



United States

Write the correct short vowel to complete each word.

a e i o u



sw__m



h__t

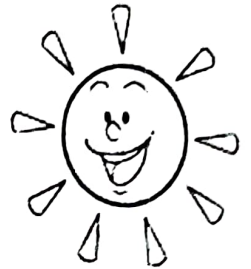

s__n

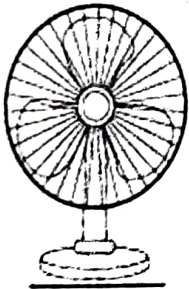

f__n

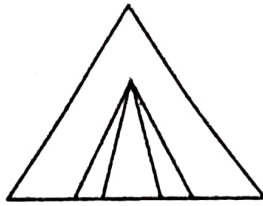

c__mp

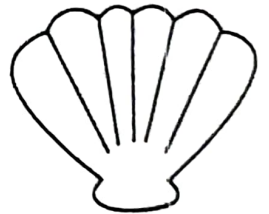

sh__ll

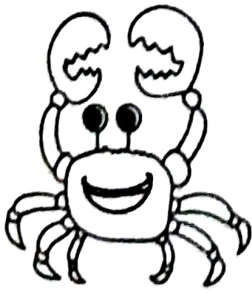

cr__b

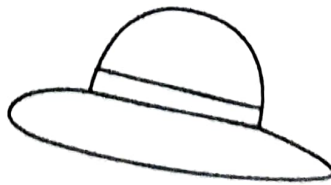

h__t

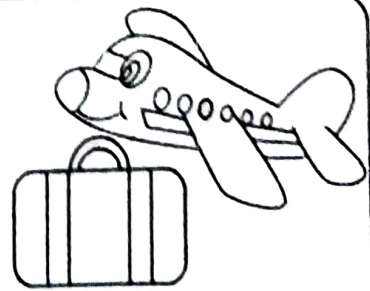

tr__p

Alphabet Letters A-Z



123kidsfun.com

Color

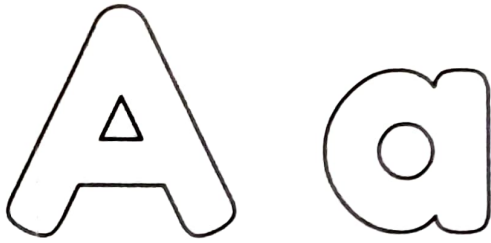

Color

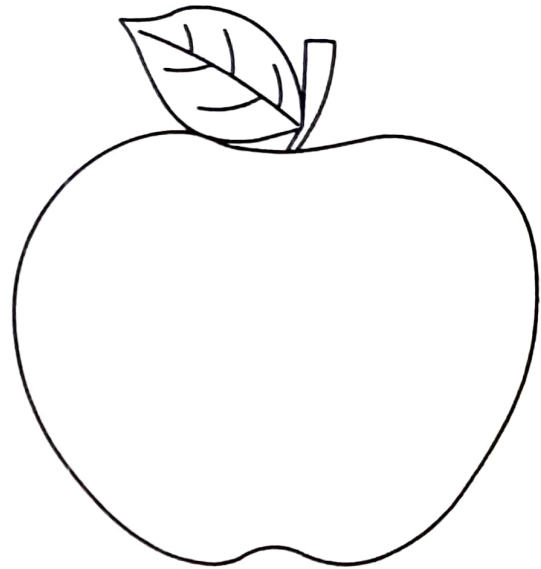

Circle it

b A a i A a C q
H a E A K a Z a
A a N o a I q d

Apple

Trace

Write

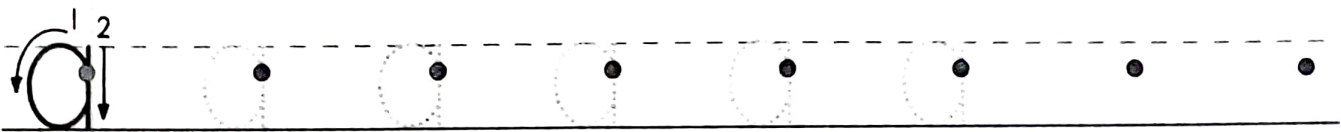
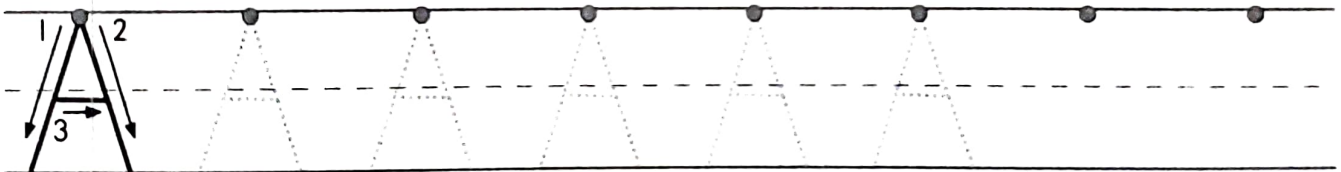

A - B - C -

- D - E - F -

- G - H - I -

Trace



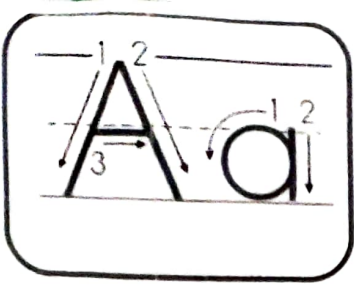

Name _____

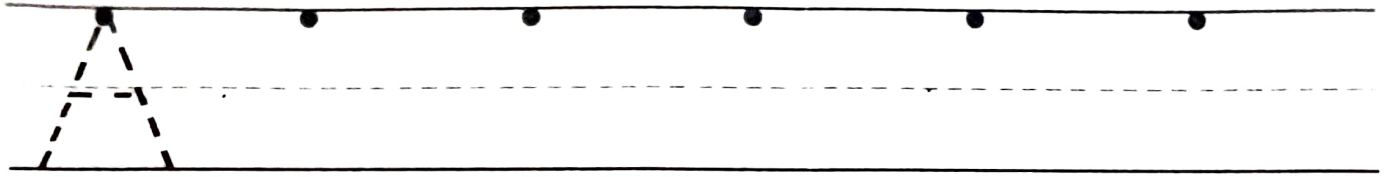

Write the missing letters.

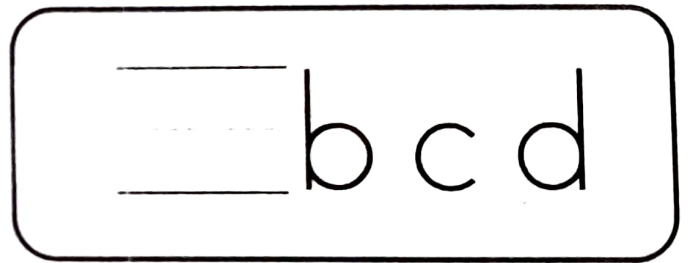
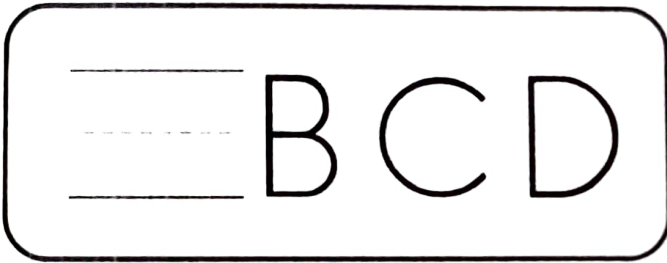

Color it.

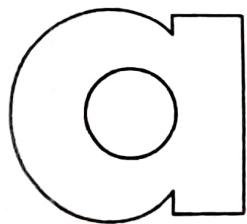
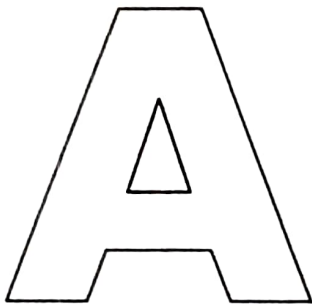

Circle it.

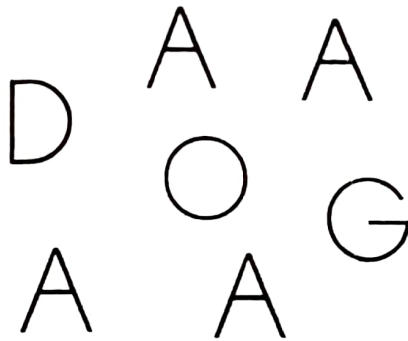

Circle it.

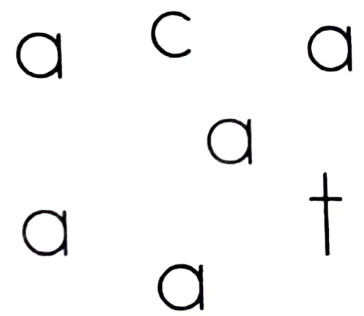

Say it. Trace and color.

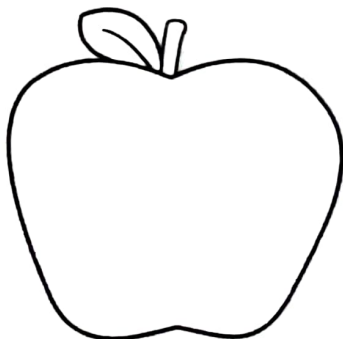

a p p p l e

Write your name.



Practice writing the letter e. Say its name and common sound (short vowel).

E e

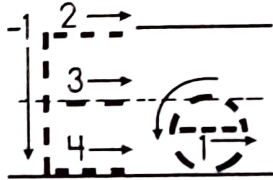

/e/
egg

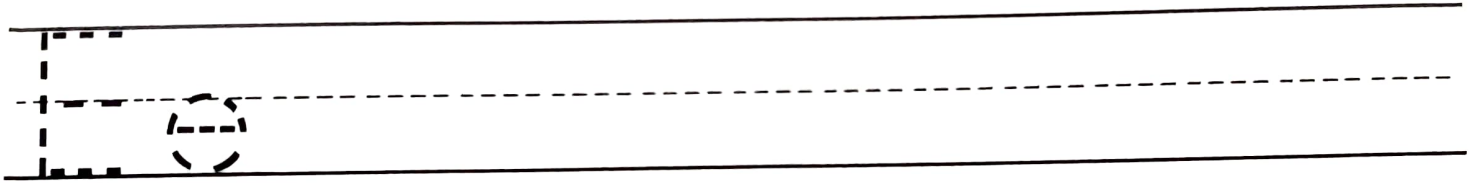

Circle the items that begin with the letter e.

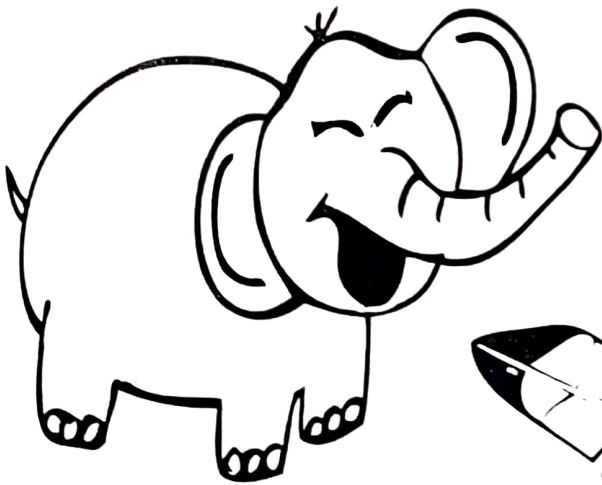

11

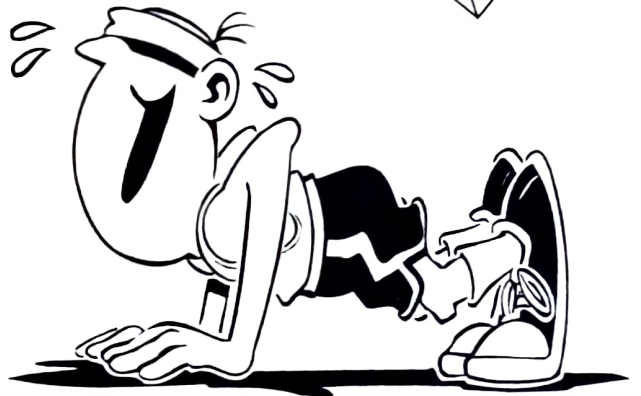
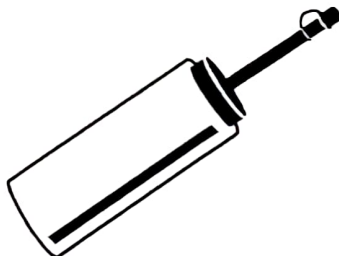
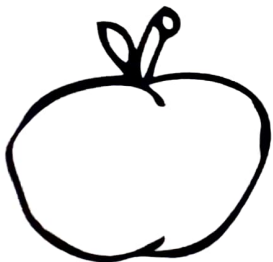
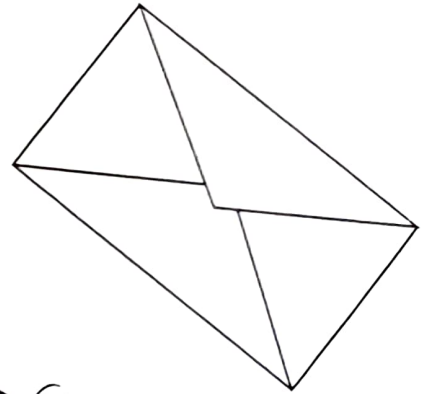

Name _____

e

Letter sound

Trace it. Sound it. Read it.

Sound it.

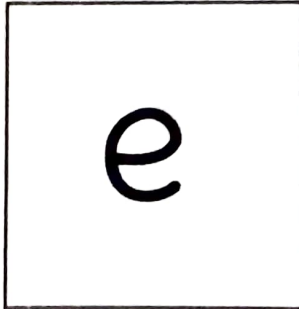

as in



elf

Trace the letter.



Sound the letter. Cut and paste the pictures under each letter sound.

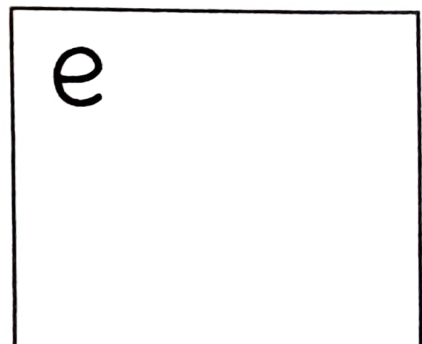
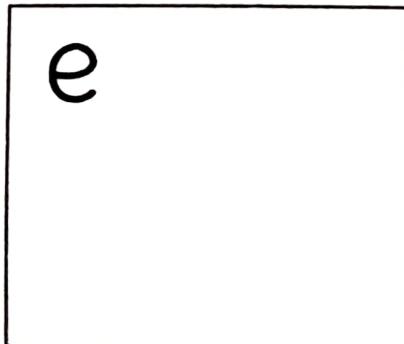
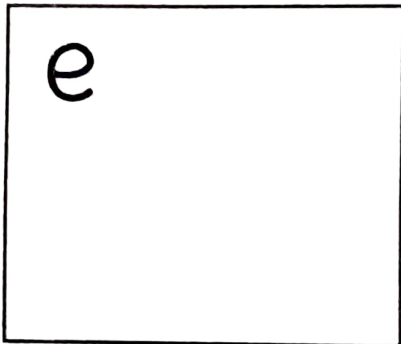

preschool365.com

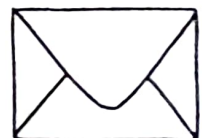
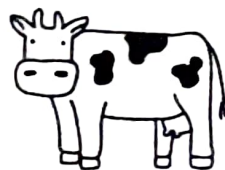
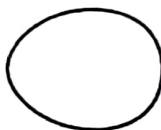
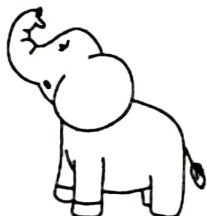
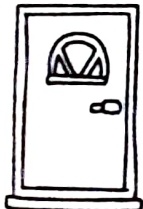

Name _____

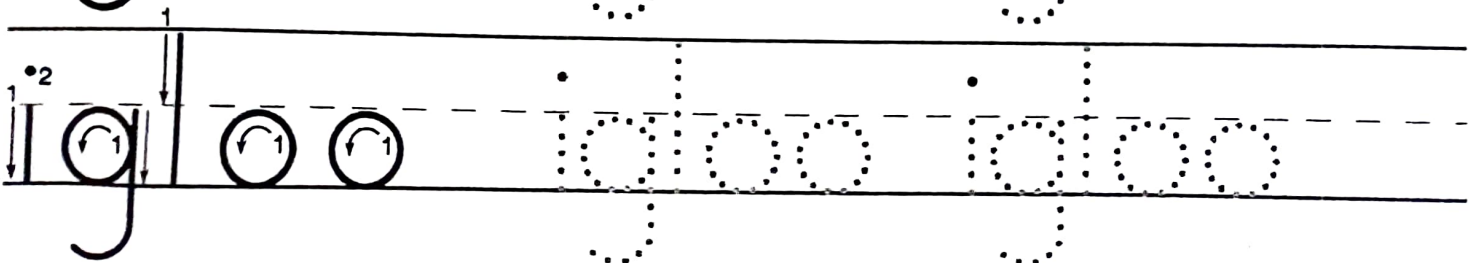
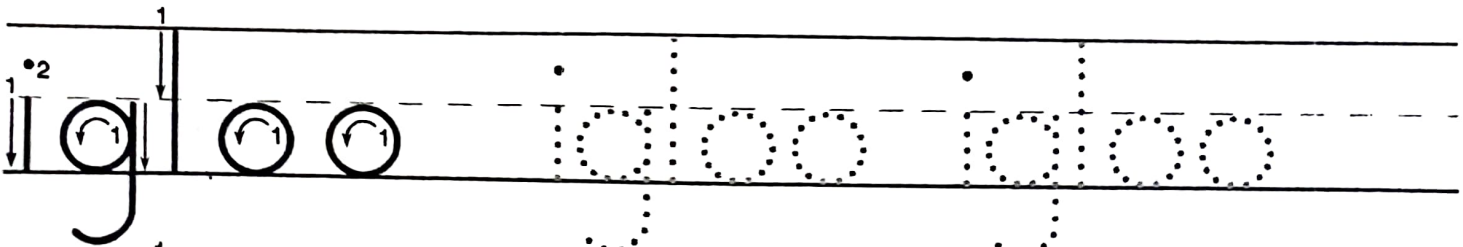
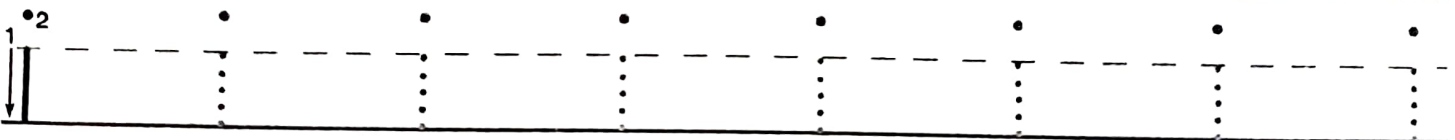
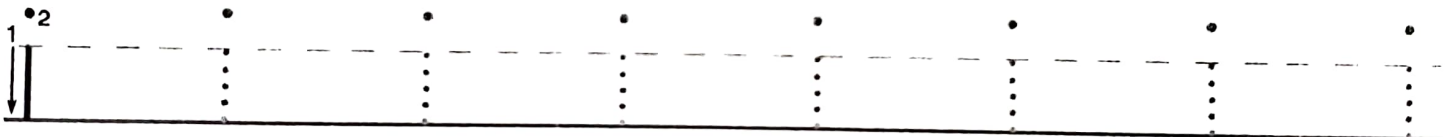
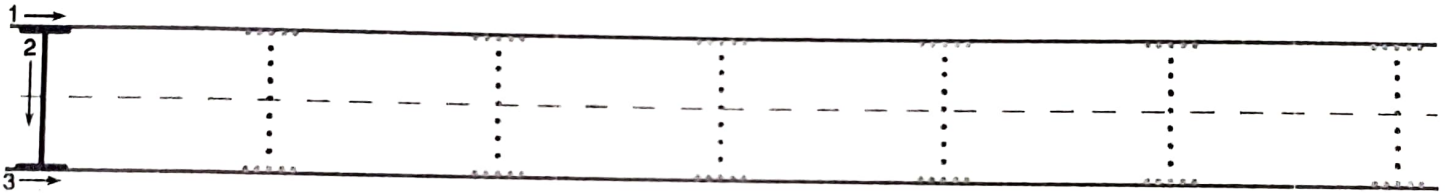
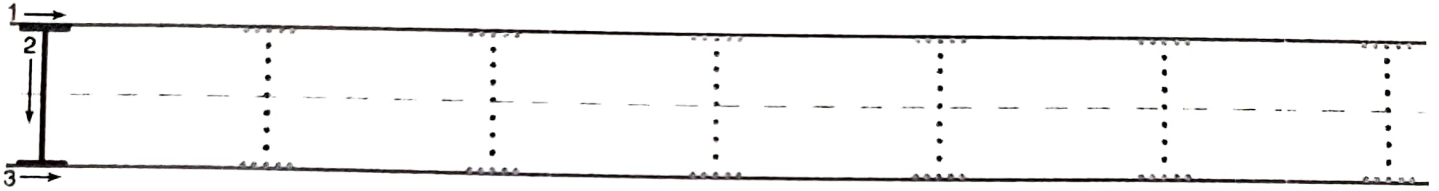
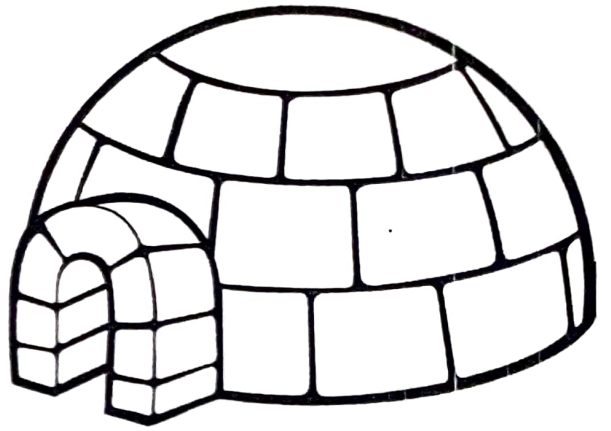
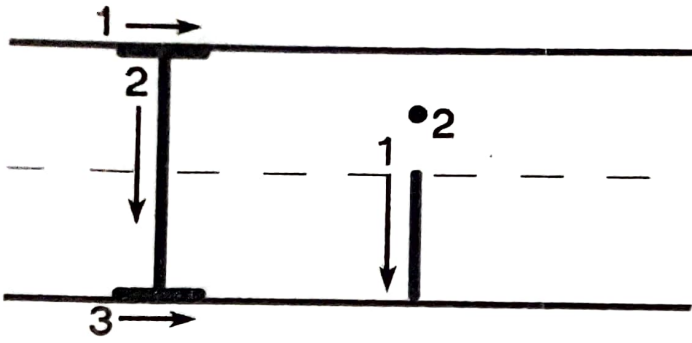

Name: _____

Date: _____

Color the letters.

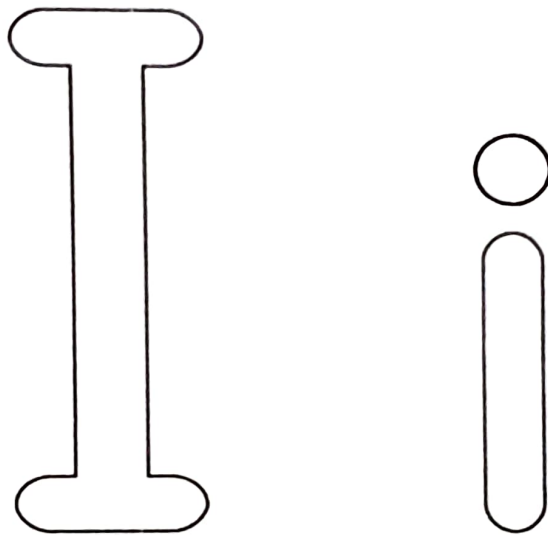

Color the images that start with the letter I.



Color the circles with the letter I or i.

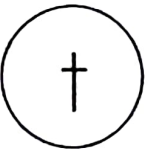
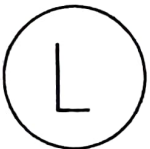
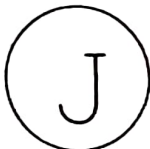
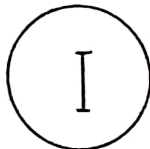
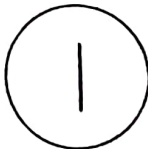

Name _____

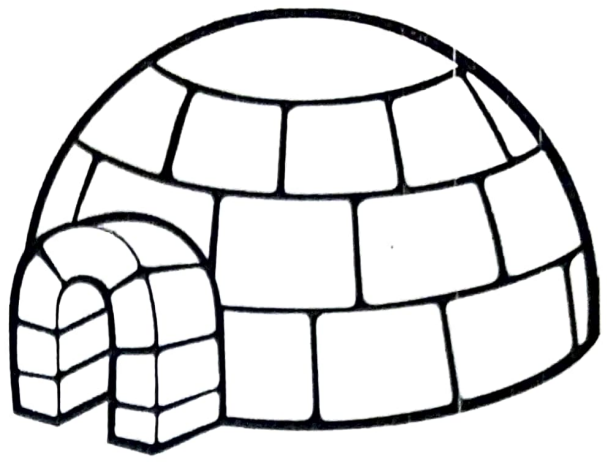
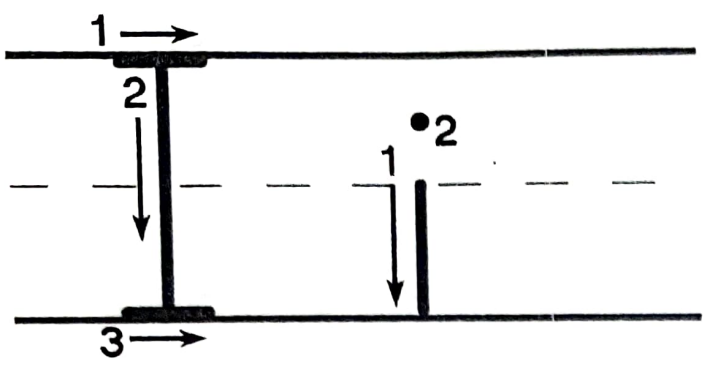

Tracing row 1: Uppercase 'I' with stroke order arrows and numbers. Followed by five dashed uppercase 'I's for tracing.

Tracing row 2: Uppercase 'I' with stroke order arrows and numbers. Followed by five dashed uppercase 'I's for tracing.

Tracing row 3: Lowercase 'i' with stroke order arrows and numbers. Followed by seven dashed lowercase 'i's for tracing.

Tracing row 4: Lowercase 'i' with stroke order arrows and numbers. Followed by seven dashed lowercase 'i's for tracing.

Tracing row 5: Letter 'j' with stroke order arrows and numbers. Followed by two solid 'j's, two dashed 'j's, and two dotted 'j's for tracing.

Tracing row 6: Letter 'j' with stroke order arrows and numbers. Followed by two solid 'j's, two dashed 'j's, and two dotted 'j's for tracing.

The Letter o

Colour in the letters.

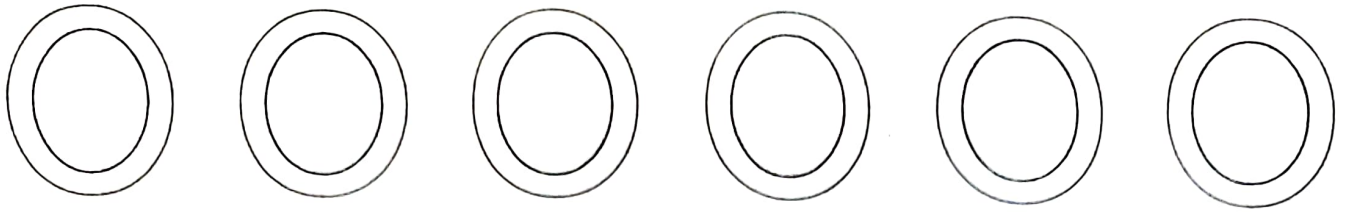

Trace over the letters.



Circle the pictures that begin with the letter o sound.

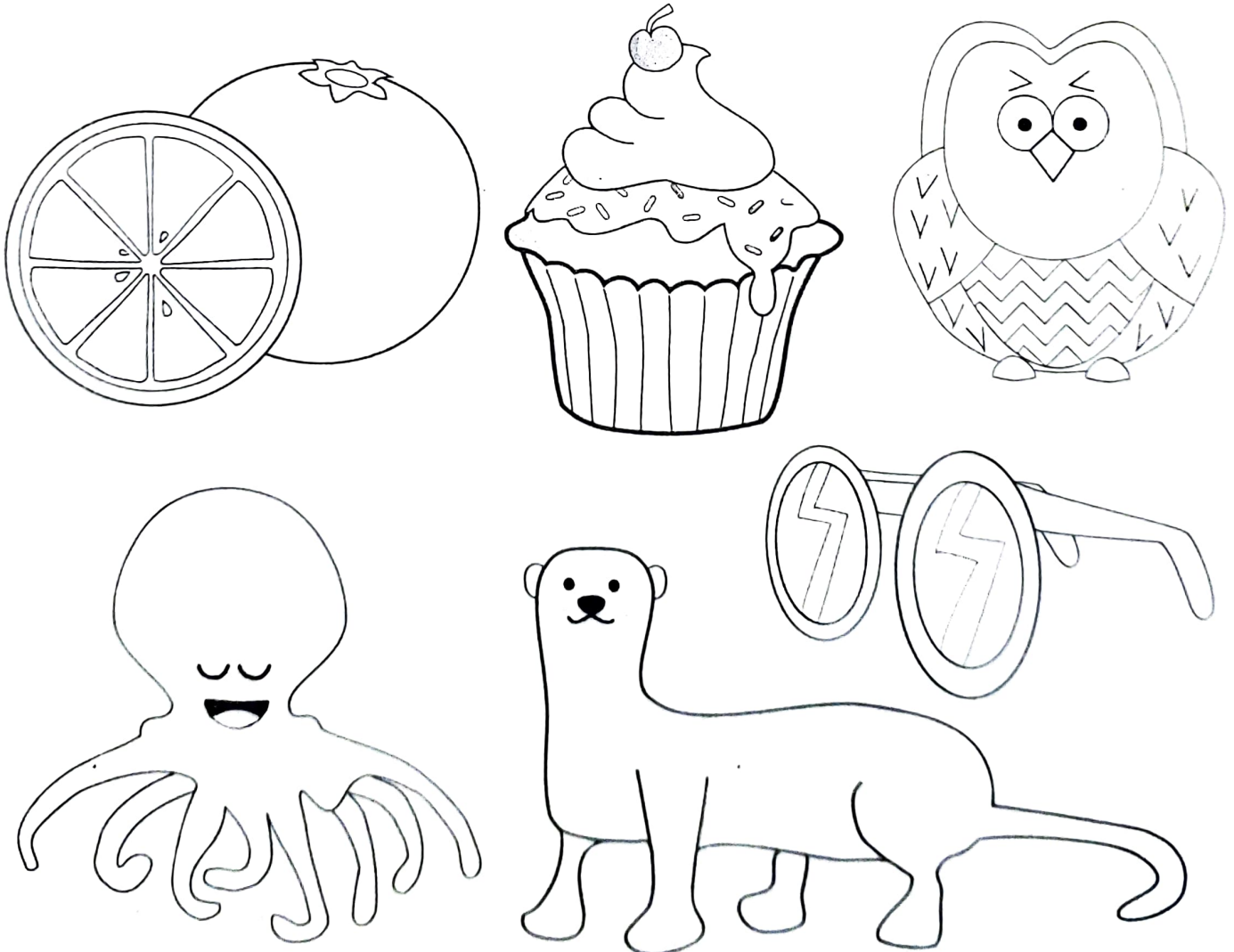

You can colour the pictures too.
86 letter o worksheet.

Orange

O o

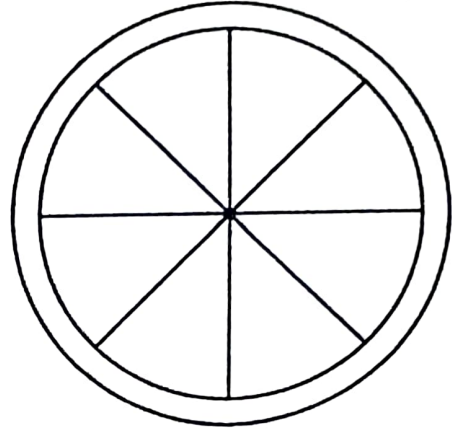

Color by letter O

G Q B D Q Q G
D B O O O D B
B O Q D B O G
G O Q G G O Q
Q O Q B D O G
Q O Q B G O Q
D O B D Q O D
D B O O O Q D
Q Q D B G D Q

Connect the dots

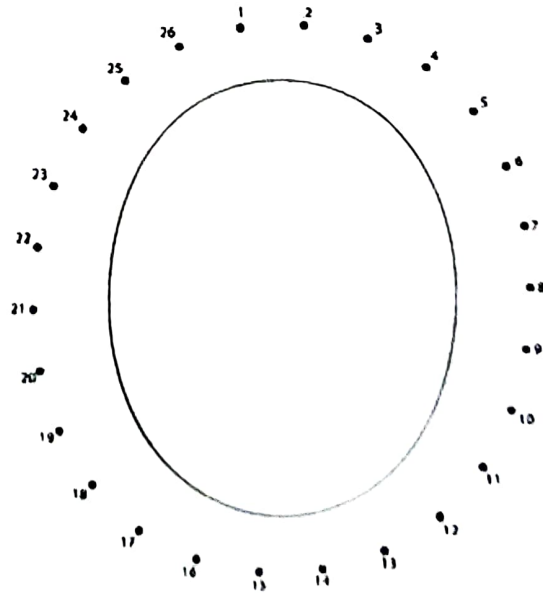

The Letter u

Colour in the letters.

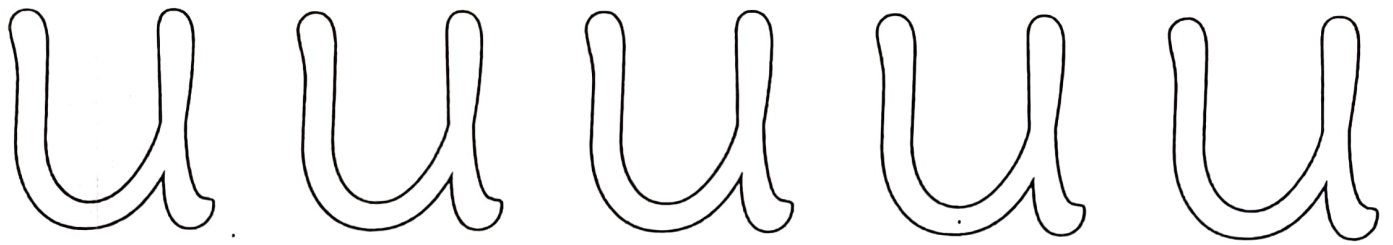

Trace over the letters.

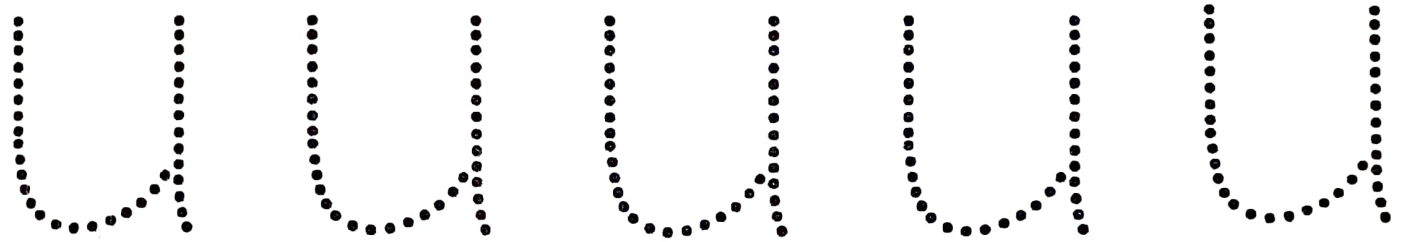

Circle the pictures that begin with the letter u sound.

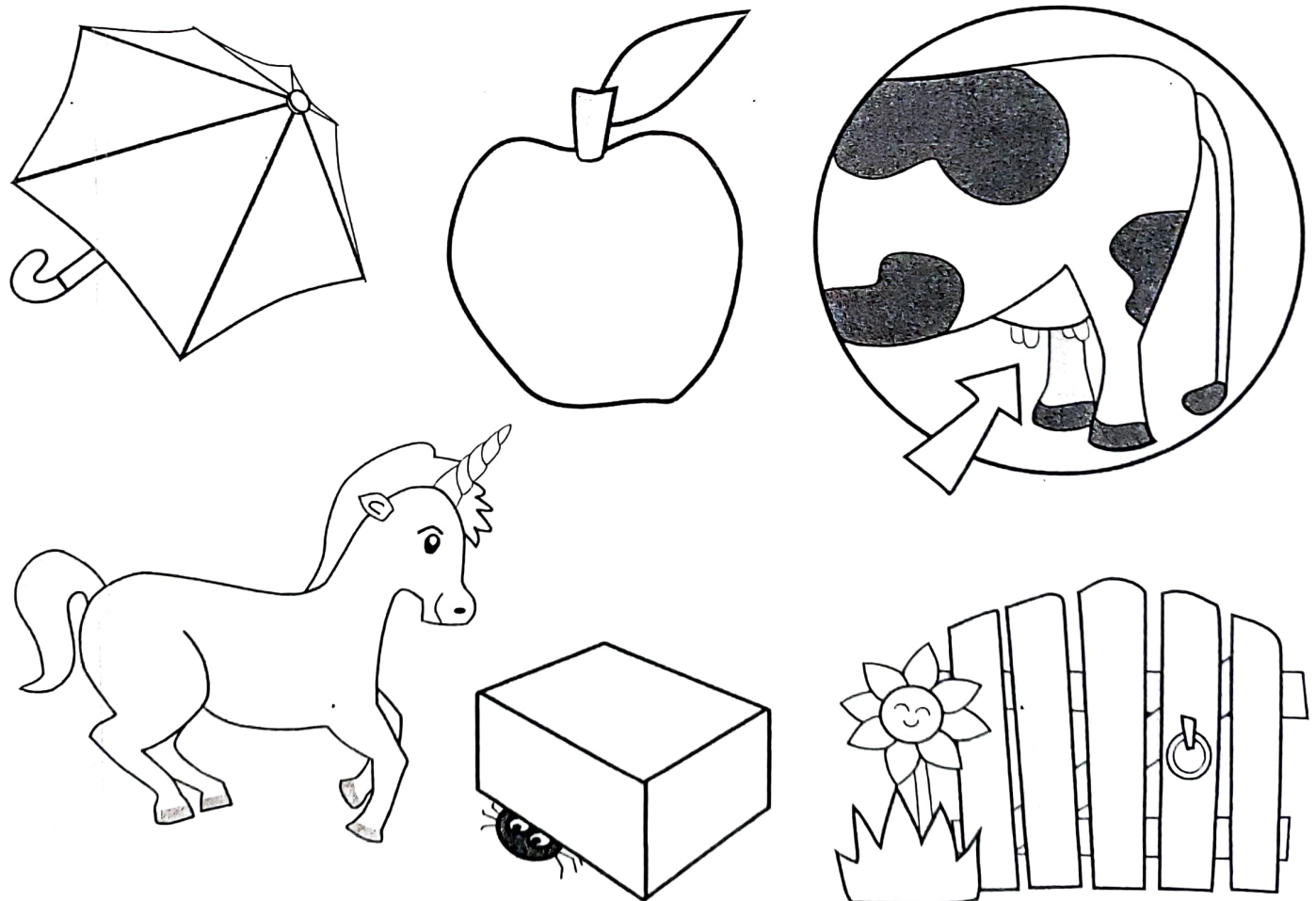

You can colour the pictures too.
54 letter u worksheet

Umbrella

Uu

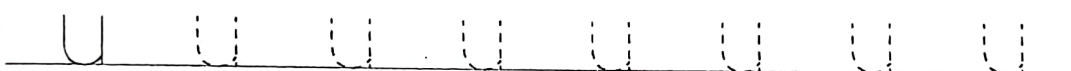
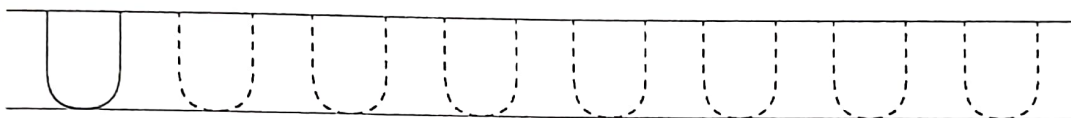
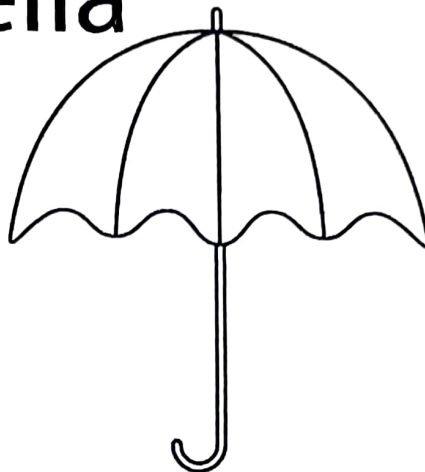

Color by letter U

V Y L Y Y L Y
Y U H V H U V
L U V H V U H
H U L V Y U V
V U V H V U L
L U V L Y U V
H U V H L U Y
H Y U U U Y V
V Y V H Y Y L

Connect the dots

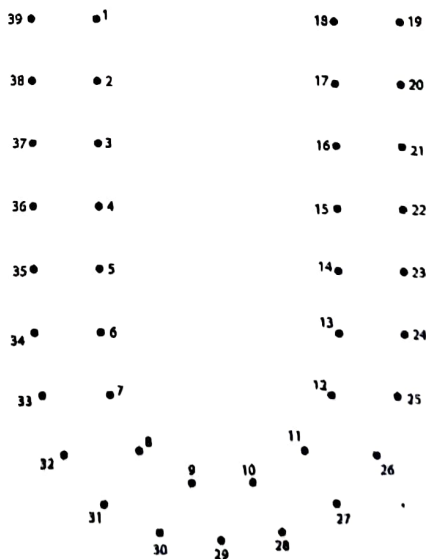

Short Uu Names



Directions: Circle the short *u* word that names each picture.

1.



mud mug bug

2.



cub tab tub

3.

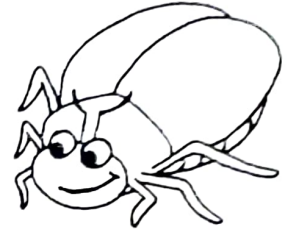

run bug bun

4.

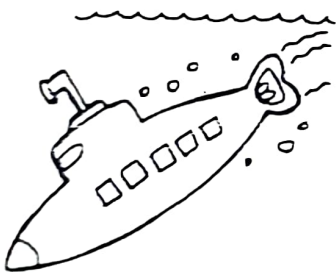

rub sun sub

5.

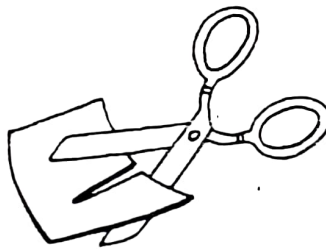

rut cut cat

6.



up cup pup

7.



muff mud puff

8.



mug mud bud

9.

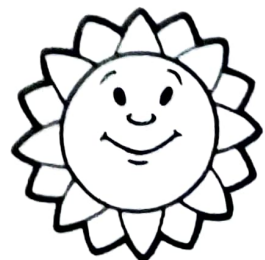

son sun sung

Vocabulary Words

Vowels long and short beginning sound

A a	
short	long
apple ant angry	acorn ape angry

A a	
short	Long
cat man sad	cake rain day

2nd Grade

E e	
short	long
elephant egg envelope	eagle eat ear

E e	
short	long
bed red yes	beach tree here

2nd grade

I i	
short	long
igloo insect iguana	ice idea island

I i	
short	long
fish sit lip	rice fice night

2nd grade

2nd grade

Oo

short	long
<u>o</u> r <u>an</u> ge	<u>o</u> val
<u>o</u> ctopus	<u>o</u> ats
<u>o</u> n	<u>o</u> wn

Oo

short	long
dog	h <u>o</u> me
b <u>o</u> x	s <u>o</u> ap
h <u>o</u> t	g <u>o</u> u <u>g</u> row

2nd grade

Uu

short	long
<u>u</u> mbrella	<u>u</u> tencils
<u>u</u> p	<u>u</u> niform
<u>u</u> s	<u>u</u> se

Uu

short	long
s <u>u</u> n	gl <u>u</u> e
c <u>u</u> p	j <u>u</u> ice
b <u>u</u> s	r <u>u</u> le